

# ELECTRICAL





# SWITCHES

**ELECTRICAL**

PART #	ITEM	PK*			
A	01150	SINGLE POLE SWITCH	1-5	\$0.85	10
		WHITE 15 AMP LEVITON	6+	\$0.74	
B	3564	SINGLE POLE SWITCH	1-5	\$0.78	10
		WHITE 15 AMP. IMPORT	6+	\$0.68	
C	01152	SINGLE POLE SWITCH	1-5	\$0.85	10
		IVORY 15 AMP. LEVITON	6+	\$0.74	
D	3372	SINGLE POLE SWITCH	1-5	\$1.71	
		BLACK 15 AMP	6+	\$1.49	
E	01156	3 WAY SWITCH	1-5	\$1.78	10
		15 AMP. LEVITON	6+	\$1.55	
F	3565	3 WAY SWITCH	1-5	\$1.43	10
		WHITE 15 AMP. IMPORT	6+	\$1.25	
G	01160	3 WAY SWITCH	1-5	\$1.78	10
		IVORY 15 AMP. LEVITON	6+	\$1.55	
H	00107	4 WAY SWITCH	1-5	\$9.14	10
		WHITE 15 AMP. LEVITON	6+	\$7.95	
I	01164	DOUBLE SWITCH	1-5	\$4.31	10
		WHITE 15 AMP. LEVITON	6+	\$3.75	
J	01168	DOUBLE SWITCH	1-5	\$4.31	10
		IVORY 15 AMP. LEVITON	6+	\$3.75	
K	625178	SINGLE POLE DECORA	1-5	\$11.49	10
		SWITCH/OUTLET WHITE 15 AMP.	6+	\$9.99	

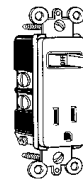
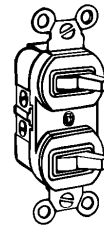

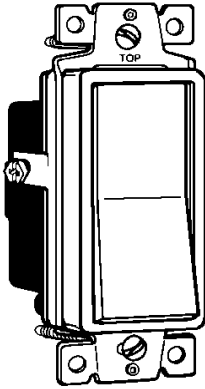

	PART #	ITEM			PK*
A	01172	SINGLE POLE DECORA SWITCH	1-5	\$2.98	10
		WHITE 15 AMP. LEVITON	6+	\$2.59	
B	3562	SINGLE DECORA SWITCH	1-5	\$2.28	10
		WHITE 15 AMP. IMPORT	6+	\$1.99	
C	01174	SINGLE POLE DECORA SWITCH	1-5	\$2.98	10
		IVORY 15 AMP. LEVITON	6+	\$2.59	
D	01178	3 WAY DECORA SWITCH	1-5	\$3.44	10
		WHITE 15 AMP. LEVITON	6+	\$2.99	
E	01182	3 WAY DECORA SWITCH	1-5	\$3.44	10
		IVORY 15 AMP. LEVITON	6+	\$2.99	
F	3563	3 WAY DECORA SWITCH	1-5	\$2.58	10
		WHITE 15 AMP IMPORT	6+	\$2.25	
G	09651	SINGLE POLE DECORA SWITCH	1-5	\$3.85	
		BLACK 15 AMP	6+	\$3.35	
H	09024	DECORA SWITCH	1-5	\$12.39	
		15A 4WAY WHITE	6+	\$10.77	

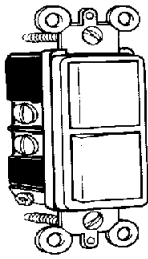



I	91420	DUAL ROCKER SWITCH	1-5	\$12.56	10
		WHITE	6+	\$10.92	



J	3021	DISPOSAL SWITCH	1-5	\$6.27	10
		WHITE LEVITON	6+	\$5.45	

# DIMMERS

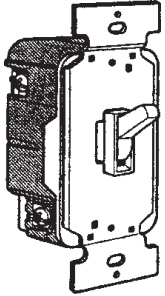
**ELECTRICAL**

PART #	ITEM	PK*			
A	00119	WIRELESS WHITE SWITCH	1-5	\$27.03	
		500 WATT/100' TRANSMISSION	6+	\$23.50	
					
B	356193	ROTARY DIMMER	1-5	\$6.03	5
		WHITE 600 WATT/120 VOLT	6+	\$5.24	
C	414912	ROTARY DIMMER	1-5	\$6.03	5
		IVORY 600 WATT/120VOLT	6+	\$5.24	
D	3284	3 WAY ROTARY DIMMER	1-5	\$7.67	5
		WHITE 600 WATT/120 VOLT	6+	\$6.67	
E	3294	3 WAY ROTARY DIMMER	1-5	\$7.67	5
		IVORY 600 WATT/120 VOLT	6+	\$6.67	
F	01190	FAN CONTROL	1-5	\$9.03	5
		WHITE 120 VOLT SINGLE POLE	6+	\$7.85	
G	01192	FAN CONTROL	1-5	\$9.03	5
		IVORY 120 VOLT SINGLE POLE	6+	\$7.85	
H	356256	DIMMER KNOB	1-5	\$1.38	
		WHITE	6+	\$1.20	
I	618264	DIMMER KNOB	1-5	\$1.38	
		IVORY	6+	\$1.20	
					

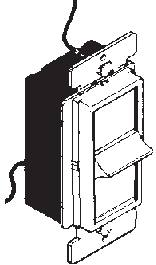
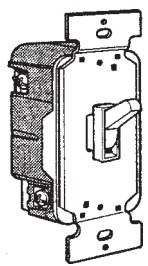

	<b>PART #</b>	<b>ITEM</b>			<b>PK*</b>
	A 01092	SLIDE DIMMER DECORA	1-5	\$12.06	10
		WHITE 600 WATT/ 120 VOLT	6+	\$10.49	
	B 564495	TOGGLE DIMMER	1-5	\$9.04	10
		WHITE SINGLE POLE 600 WATT	6+	\$7.85	





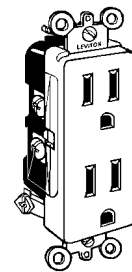
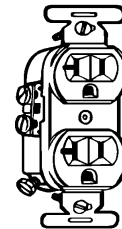
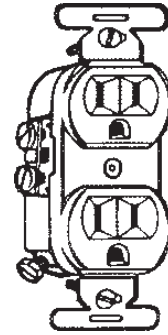

# RECEPTACLES

**ELECTRICAL**

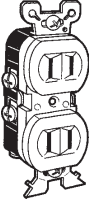
PART #	ITEM	PK*
A	309476 DUPLEX RECEPTACLE WHITE 15A-4 HOLE/SIDE WIRED LEVITON	1-5 \$0.69 10 6+ \$0.60
B	3567 DUPLEX RECEPTACLE WHITE 15A-4HOLE/SIDE WIRED IMPORT	1-5 \$0.57 10 6+ \$0.50
C	309369 DUPLEX RECEPTACLE IVORY 15A-4HOLE/SIDE WIRED LEVITON	1-5 \$0.69 10 6+ \$0.60
D	06938 DUPLEX RECEPTACLE WHITE 14GA - 8 HOLE QUIKWIRE LEVITON	1-5 \$0.97 10 6+ \$0.85
E	06937 DUPLEX RECEPTACLE IVORY 14GA - 8HOLE QUIKWIRE LEVITON	1-5 \$0.97 10 6+ \$0.85
F	01166 DUPLEX RECEPTACLE WHITE 15 AMP 12 GA BACKWIRE	1-5 \$3.00 10 6+ \$2.61
G	07061 DUPLEX RECEPTACLE IVORY 15 AMP 12 GA BACKWIRE	1-5 \$3.00 10 6+ \$2.61
H	87508 20 AMP DUPLEX RECEPTACLE WHITE-SIDE WIRED	1-5 \$2.65 10 6+ \$2.30
I	87509 20 AMP DUPLEX RECEPTACLE IVORY-SIDE WIRED	1-5 \$2.65 10 6+ \$2.30
J	647914 DECORA DUPLEX RECEPTACLE WHITE 15 AMP LEVITON	1-5 \$1.93 10 6+ \$1.68
K	3566 DECORA DUPLEX RECEPTACLE WHITE 15 AMP IMPORT	1-5 \$1.48 10 6+ \$1.29
L	3295 DECORA DUPLEX RECEPTACLE IVORY 15 AMP. LEVITON	1-5 \$1.93 10 6+ \$1.68
M	06761 DECORA DUPLEX RECEPTACLE BLACK 15 AMP	1-5 \$3.20 10 6+ \$2.79
N	3337 DECORA DUPLEX RECEPTACLE WHITE 20 AMP	1-5 \$6.60 10 6+ \$5.75

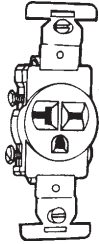

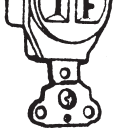
	<b>PART #</b>	<b>ITEM</b>			<b>PK*</b>
	A 01191	DUPLEX NO GROUND	1-5	\$2.84	10
		RECEPTACLE - WHITE	6+	\$2.47	
	B 3011	DUPLEX RECEPTACLE	1-5	\$2.07	10
		WHITE 15A-SELF GROUNDING LEVITON	6+	\$1.80	
	C 624338	SINGLE OUTLET RECEPTACLE	1-5	\$4.20	10
		WHITE - 250 VOLT 20 AMP.	6+	\$3.65	
	D 353615	SINGLE OUTLET RECEPTACLE	1-5	\$4.20	10
		IVORY - 250 VOLT 20 AMP.	6+	\$3.65	
	E 3296	SINGLE OUTLET RECEPTACLE	1-5	\$3.65	10
		WHITE - 125 VOLT 20 AMP.	6+	\$2.91	
	F 3297	SINGLE OUTLET RECEPTACLE	1-5	\$3.35	10
		IVORY - 125 VOLT 20 AMP.	6+	\$2.91	



PART #	ITEM	PK*
A	87536 G.F.I. RECEPTACLE W/ COVER WHITE W/ WHITE BUTTONS 120 VOLT 15 AMP. IMPORT	1-5 \$10.87 10 6+ \$9.45
B	3568 G.F.I. RECEPTACLE W/ COVER WHITE W/ WHITE BUTTONS 120 VOLT 20 AMP. IMPORT	1-5 \$13.77 10 6+ \$11.97
C	87538 G.F.I. RECEPTACLE W/ COVER IVORY W/ IVORY BUTTONS 120 VOLT 15 AMP. IMPORT	1-5 \$10.87 10 6+ \$9.45
D	880039 LEVITON GFCI WHITE W/ RED & BLACK BUTTONS - 15 AMP SMARTLOCK	1-5 \$12.98 10 6+ \$14.93
E	879965 LEVITON GFCI IVORY W/ RED & BLACK BUTTONS - 15 AMP SMARTLOCK	1-5 \$16.61 10 6+ \$14.45
F	880138 LEVITON GFCI WHITE W/ RED & BLACK BUTTONS - 20 AMP SMARTLOCK RED/BLACK	1-5 \$16.61 10 6+ \$14.45
G	880021 LEVITON GFCI IVORY W/ RED & BLACK BUTTONS - 20 AMP SMARTLOCK	1-5 \$18.91 10 6+ \$16.45
H	31525 LEVITON G.F.C. RECEPTACLE BLACK-BLACK BUTTONS 15 AMP	1-5 \$18.91 6+ \$16.45

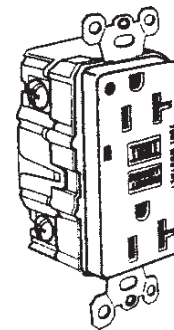
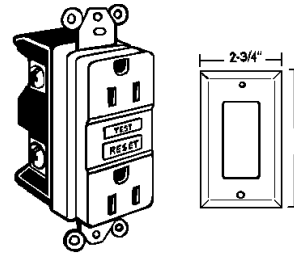

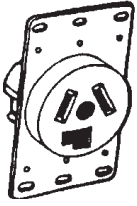
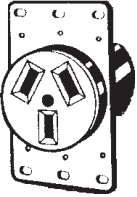
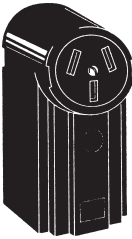
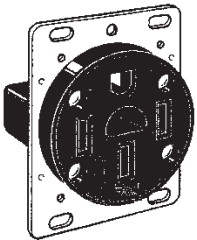
	PART #	ITEM			PK*
	A 07072	30 AMP SURFACE MOUNT	1-5	\$2.83	1
		DRYER OUTLET 125/250 VOLT	6+	\$2.46	
	B 91636	50 AMP SURFACE MOUNT	1-5	\$3.00	1
		RANGE OUTLET BROWN 125/250 VOLT	6+	\$2.61	
	C 07068	50 AMP RANGE OUTLET	1-5	\$4.73	1
		125/250 VOLT	6+	\$4.12	
	D 80007	50 AMP SURFACE MOUNT	1-5	\$12.75	1
		OUTLET-4 WIRE	6+	\$11.08	

# WALL PLATES

**ELECTRICAL**

PART #	ITEM	PK*
A	87518 BLANK SINGLE GANG	1-5 \$0.28 25
	WHITE	6+ \$0.24
B	87519 BLANK SINGLE GANG	1-5 \$0.28 25
	IVORY	6+ \$0.24
C	07448 BLANK SINGLE GANG-WHITE	1-5 \$0.63 25
	OVERSIZED UNBREAKABLE	6+ \$0.55
D	07612 BLANK 2 GANG	1-5 \$0.58 25
	WHITE	6+ \$0.50
E	07504 BLANK 2 GANG	1-5 \$0.58 25
	IVORY	6+ \$0.50
F	3419 BLANK 2 GANG COVER-WHITE	1-5 \$1.89 25
	OVERSIZED UNBREAKABLE	6+ \$1.65
G	128900 SINGLE SWITCH COVER	1-5 \$0.28 25
	WHITE	6+ \$0.24
H	244780 SINGLE SWITCH COVER	1-5 \$0.28 25
	IVORY	6+ \$0.24
I	07432 SINGLE SWITCH COVER-WHITE	1-5 \$0.63 25
	OVERSIZED UNBREAKABLE	6+ \$0.55
J	145417 DOUBLE SWITCH COVER	1-5 \$0.54 20
	WHITE	6+ \$0.47
K	244806 DOUBLE SWITCH COVER	1-5 \$0.54 20
	IVORY	6+ \$0.47
L	07440 DOUBLE SWITCH COVER-WHITE	1-5 \$1.13 20
	OVERSIZED UNBREAKABLE	6+ \$0.99

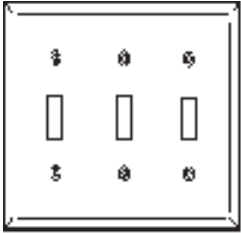

	PART #	ITEM			PK*
	A 87523	TRIPLE SWITCH COVER	1-5	\$0.91	20
		WHITE	6+	\$0.79	
	B 87522	TRIPLE SWITCH COVER	1-5	\$0.91	20
		IVORY	6+	\$0.79	
	C 07592	TRIPLE SWITCH COVER-WHITE	1-5	\$1.25	20
		OVERSIZED UNBREAKABLE	6+	\$1.09	

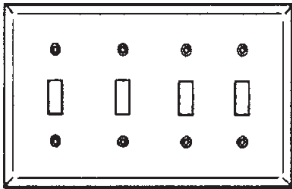
	D 573329	4 GANG SWITCH COVER	1-5	\$1.71	10
		WHITE	6+	\$1.49	

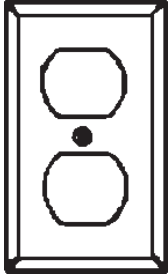
	E 128918	DUPLEX RECEPTACLE COVER	1-5	\$0.32	25
		WHITE	6+	\$0.28	
	F 244822	DUPLEX RECEPTACLE COVER	1-5	\$0.32	25
		IVORY	6+	\$0.28	
	G 07436	DUPLEX RECEPTACLE COVER	1-5	\$0.63	25
		WHITE OVERSIZED UNBREAKABLE	6+	\$0.55	
	H 467236	DUPLEX RECEPTACLE COVER	1-5	\$0.44	
		WHITE UNBREAKABLE	6+	\$0.39	
		MIDSIZE			



# WALL PLATES

**ELECTRICAL**

PART #	ITEM	PK*			
A	147967	DOUBLE DUPLEX RECEPTACLE	1-5	\$0.64	20
		COVER-WHITE	6+	\$0.56	
B	145599	DOUBLE DUPLEX RECEPTACLE	1-5	\$0.64	20
		COVER-IVORY	6+	\$0.56	
C	07456	DOUBLE DUPLEX RECEPTACLE	1-5	\$1.09	20
		COVER-WHITE OVERSIZED	6+	\$0.95	
		UNBREAKABLE			
D	145441	COMBINATION COVER	1-5	\$0.90	20
		WHITE	6+	\$0.79	
E	244848	COMBINATION COVER	1-5	\$0.90	20
		IVORY	6+	\$0.79	
F	07396	COMBINATION COVER	1-5	\$1.09	20
		WHITE OVERSIZED	6+	\$0.95	
G	3589	DECORA 1 GANG	1-5	\$	20
		WHITE	6+	\$	
H	473538	G.F.I. / DECORA SWITCH	1-5	\$0.52	20
		COVER - WHITE	6+	\$0.46	
I	473520	G.F.I. / DECORA SWITCH	1-5	\$0.52	20
		COVER - IVORY	6+	\$0.46	
J	09655	G.F.I. / DECORA SWITCH	1-5	\$0.72	20
		COVER - WHITE OVERSIZED	6+	\$0.63	

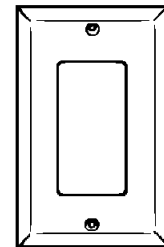
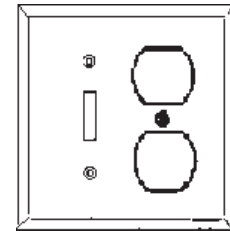
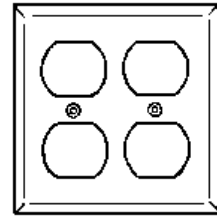

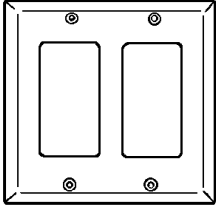
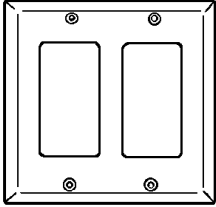
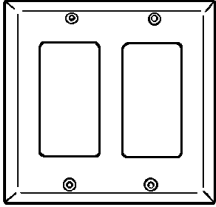
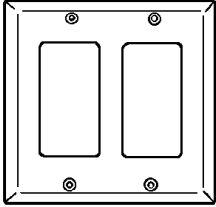
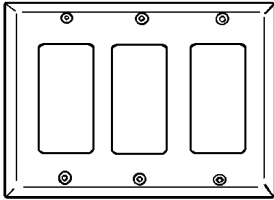
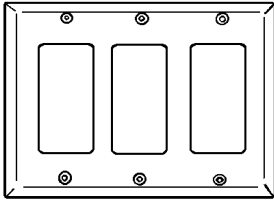
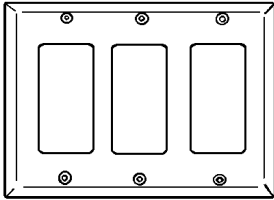
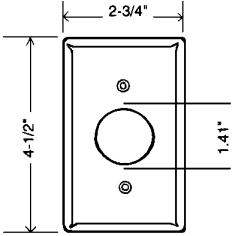
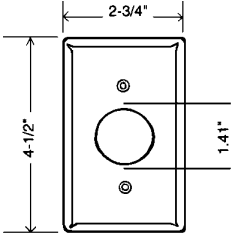
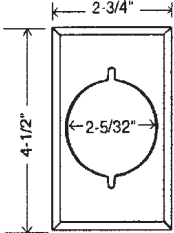
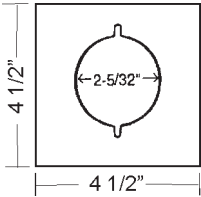
	PART #	ITEM			PK*
	A 10202	DECORA DOUBLE SWITCH	1-5	\$1.06	20
		COVER - WHITE	6+	\$0.93	
	B 3590	DECORA PLATE 2 GANG	1-5	\$	20
		WHITE	6+	\$	
	C 10201	DECORA DOUBLE SWITCH	1-5	\$1.06	20
		COVER - IVORY	6+	\$0.93	
	D 91635	DECORA DOUBLE SWITCH	1-5	\$1.48	20
		COVER OVERSIZED - WHITE	6+	\$1.29	
	E 10206	DECORA TRIPLE SWITCH	1-5	\$1.31	20
		COVER - WHITE	6+	\$1.14	
	F 07322	DECORA TRIPLE SWITCH	1-5	\$1.42	
		COVER-BLACK	6+	\$1.24	
	G 10205	DECORA TRIPLE SWITCH	1-5	\$1.31	20
		COVER - IVORY	6+	\$1.14	
	H 626622	SINGLE RECEPTACLE COVER	1-5	\$0.29	25
		WHITE	6+	\$0.26	
	I 271759	SINGLE RECEPTACLE COVER	1-5	\$0.29	25
		IVORY	6+	\$0.26	
	J 07076	SURFACE MOUNT OUTLET	1-5	\$2.01	10
		CHROME COVER PLATE	6+	\$1.75	
		FITS 1 GANG BOX			
	K 07107	SURFACE MOUNT OUTLET	1-5	\$3.73	10
		COVER FITS 2 GANG BOX	6+	\$3.25	
		CHROME			

# WALL PLATES

**ELECTRICAL**

PART #	ITEM	PK*
A	01099 2 GANG DECORA X BLANK PLATE, WHITE	1-5 \$2.58 20 6+ \$2.25
B	91630 2 GANG DECORA X BLANK PLATE, IVORY	1-5 \$2.58 20 6+ \$2.25
C	00594 2 GANG DECORA X BLANK PLATE, WHITE-METAL	1-5 \$4.88 20 6+ \$4.25
D	91631 2 GANG DECORA X RECEPTACLE, WHITE	1-5 \$1.13 20 6+ \$0.99
E	91633 2 GANG BLANK X TOGGLE PLATE, WHITE	1-5 \$2.81 20 6+ \$2.45
F	91632 2 GANG BLANK X TOGGLE PLATE, IVORY	1-5 \$2.81 20 6+ \$2.45
G	356474 3 GANG TOGGLE/TOGGLE RECEPTACLE, WHITE	1-5 \$1.13 20 6+ \$0.99
H	356447 3 GANG TOGGLE/TOGGLE RECEPTACLE-IVORY	1-5 \$1.13 20 6+ \$0.99
I	00540 2 GANG BLANK X DUPLEX WHITE	1-5 \$2.81 20 6+ \$2.45
J	138131 2 GANG TOGGLE DECORA WHITE	1-5 \$1.16 20 6+ \$1.01
K	07517 2 GANG TOGGLE DECORA IVORY	1-5 \$1.16 20 6+ \$1.01

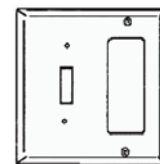
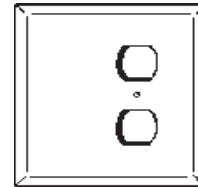
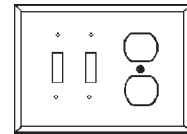
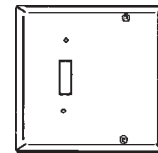
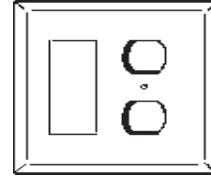
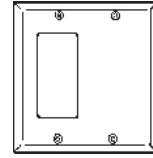

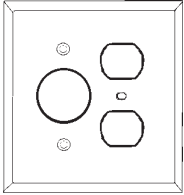
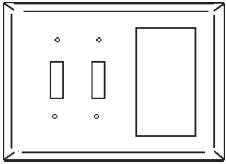
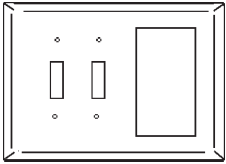
	<b>PART #</b>	<b>ITEM</b>			<b>PK*</b>
	A 00513	2 GANG A. C. X DUPLEX	1-5	\$5.70	20
		WHITE	6+	\$4.96	
	B 91773	3 GANG DECORA	1-5	\$1.69	20
		TOGGLE/TOGGLE PLATE, WHITE	6+	\$1.94	
	C 09657	3 GANG TOG/TOG DECORA	1-5	\$1.94	20
		PLATE, IVORY	6+	\$1.69	



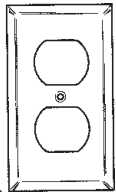
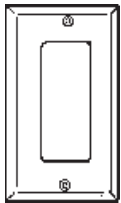
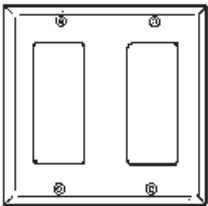
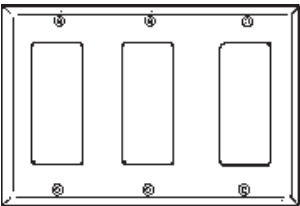

**MIRRORED WALL PLATES**

	D 00505	BEVELED MIRROR DUPLEX	1-5	\$5.69	1
			6+	\$4.95	
	E 86535	BELVELED MIRROR	1-5	\$9.54	1
		DECORA COVER PLATE	6+	\$8.30	
	F 86536	BELVELED MIRROR 2 GANG	1-5	\$13.14	1
		DECORA COVER PLATE	6+	\$11.43	
	G 86537	BELVELED MIRROR 3 GANG	1-5	\$19.71	1
		DECORA COVER PLATE	6+	\$17.14	



# COVER UP PLATES

**ELECTRICAL**

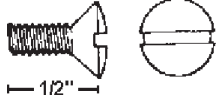
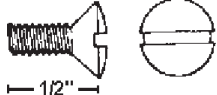
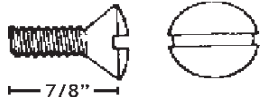
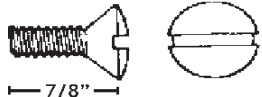

PART #	ITEM	PK*	PK*	PK*	
A	3398	SWITCH PLATE	1-5	\$3.16	
		WHITE MASQUE	5+	\$2.75	
B	3402	TOGGLE COVER UP	1-5	\$3.16	
		WHITE-TAYMAC	6+	\$2.75	
C	3429	AD20W RECEPTACLE PLATE	1-5	\$2.57	
		WHITE-TAYMAC	6+	\$2.24	
D	00541	MASQUE DECORATIVE PLATE	1-5	\$1.89	
		WHITE	6+	\$1.65	
E	91768	MASQUE DECORATIVE PLATE	1-5	\$1.89	
		IVORY	6+	\$1.65	
F	87520	COVER PLATE SCREW	1-5	\$4.58	
		WHITE - 100 PK.	6+	\$3.99	
G	87521	COVER PLATE SCREW	1-5	\$4.58	
		IVORY - 100 PK.	6+	\$3.99	
H	87532	LONG COVER PLATE SCREW	1-5	\$6.84	
		7/8" WHITE - 50 PK.	6+	\$5.95	
I	87527	LONG COVER PLATE SCREW	1-5	\$6.84	
		7/8" IVORY - 50 PK.	6+	\$5.95	

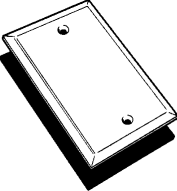
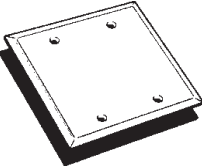
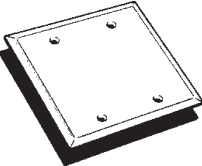
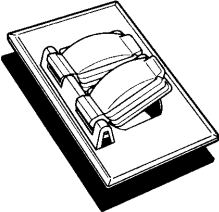
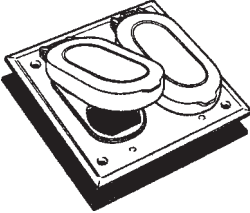
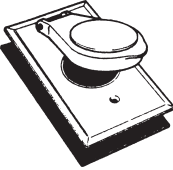

	PART #	ITEM			PK*
	A 357332	BLANK WEATHERPROOF COVER	1-5	\$0.94	1
		1 GANG - GRAY	6+	\$0.82	
	B 3006	BLANK WATERPROOF COVER	1-5	\$0.94	
		1 GANG-WHITE	6+	\$0.82	
	C 357155	BLANK WEATHERPROOF COVER	1-5	\$2.13	1
		2 GANG - GRAY	6+	\$1.85	
	D 666073	DUPLEX WEATHERPROOF	1-5	\$2.35	1
		COVER-GRAY	6+	\$2.05	
	E 357395	SNAP COVER 2 GANG	1-5	\$7.50	1
		GRAY	6+	\$6.55	
	F 357346	SINGLE RECEPTACLE	1-5	\$3.39	1
		OR SWITCH WEATHERPROOF	6+	\$2.95	
		COVER-GRAY			

# EXTERIOR BOXES

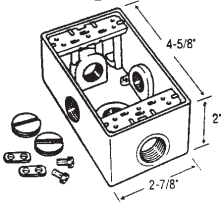
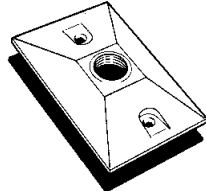
**ELECTRICAL**

PART #	ITEM		PK*			
A	666081	1 GANG OUTLET BOX	1-5	\$3.16	1	
		GALVANIZED 1/2" HOLES	6+	\$2.75		
B	05942	1/2" TAPPED 1 HOLE	1-5	\$1.78	1	
		WEATHERPROOF 1 GANG -GRAY	6+	\$1.55		
C	05809	1/2" TAPPED 3 HOLE-	1-5	\$2.47	1	
		WEATHERPROOF 1 GANG -GRAY	6+	\$2.15		
D	87516	G.F.I. WEATHERPROOF COVER	1-5	\$3.39	1	
		GRAY	6+	\$2.95		

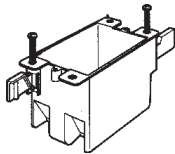
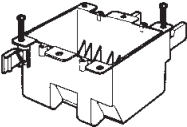
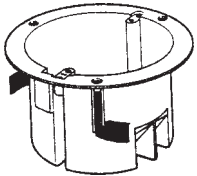
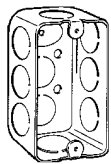
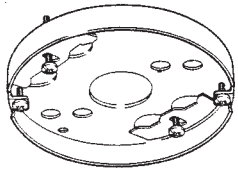
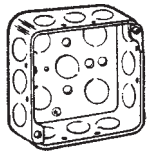

	PART #	ITEM			PK*
	A 06356	1 GANG BLUE PLASTIC TIGER	1-5	\$2.07	1
		BOX W/ CLIPS	6+	\$1.80	
	B 06349	2 GANG BLUE PLASTIC TIGER	1-5	\$2.12	1
		BOX W/ CLIPS	6+	\$1.85	
	C 06352	3-0 BLUE PLASTIC TIGER BOX	1-5	\$2.86	
			6+	\$2.49	
	D 06220	1 GANG STEEL HANDY BOX	1-5	\$1.84	1
			6+	\$1.60	
	E 454975	3-0 PANCAKE BOX	1-5	\$1.71	1
		GALVANIZED	6+	\$1.49	
	F 06304	2 GANG BOX 1/2KO	1-5	\$2.24	1
		GALVANIZED	6+	\$1.95	

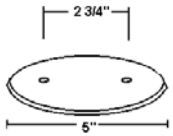
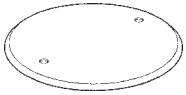
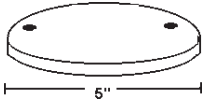

# INTERIOR BOXES

**ELECTRICAL**



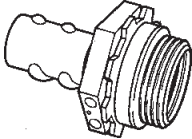
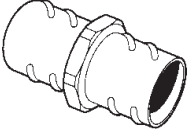

PART #	ITEM	1-5	6+	\$	PK*	
A 00550	ROUND BLANK COVER - 5"	1-5		\$2.24	1	
	WHITE, 2 3/4" HOLE SPACING	6+		\$1.95		
B 09412	ROUND BLANK COVER - 5"	1-5		\$1.25	1	
	WHITE, 3 1/2" HOLE SPACING	6+		\$1.09		
C 87530	BLANK CEILING PLATE - 5"	1-5		\$2.98	1	
	WHITE 1" DEEP, 2 3/4" HOLE SPACING	6+		\$2.59		



# ELECTRICAL

	PART #	ITEM			PK*
	A	3/4" SCREW IN CONNECTOR	1-5	\$0.68	1
		FITS 3/4" FLEX CONDUIT	6+	\$0.59	
	B	1/2" SCREW IN CONNECTOR	1-5	\$0.56	
		FITS 1/2" FLEX CONDUIT	6+	\$0.49	
	C	1/2" SCREW IN COUPLING	1-5	\$1.13	1
			6+	\$0.99	
	D	1/2" FLEX ALUM CONDUIT	1-5	\$57.48	
			6+	\$49.99	
	E	1/2X10' METALEMT CONDUIT	1-5	\$4.58	
			6+	\$3.99	
	F	3/4X10' METALEMT CONDUIT	1-5	\$8.03	
			6+	\$6.99	



PART #	ITEM				PK*
A	05684	1/2" ROMEX CONNECTOR	1-5	\$0.56	1
			6+	\$0.49	
					
B	437103	1/2" 90 DEGREES ANGLE CONNECTOR	1-5	\$2.15	1
			6+	\$2.19	
					
C	665596	3/4" 90 DEGREES ANGLE CONNECTOR	1-5	\$3.66	1
			6+	\$3.19	
					
D	315294	6 OUTLET POWER STRIP W/ 3' CORD SURGE PROTECTOR	1-5	\$9.13	1
			6+	\$7.94	
					

**ELECTRICAL**

**CORDS**

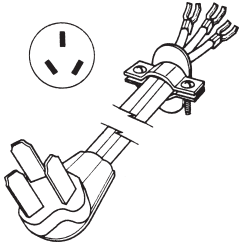
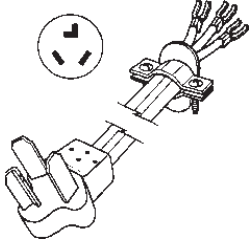
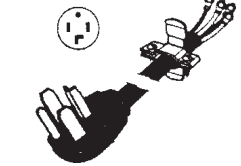
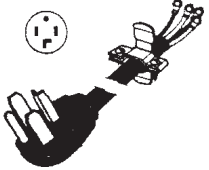
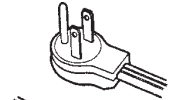
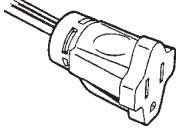







	PART #	ITEM			PK*	
	A	753467	25 FT. EXTENSION CORD	1-5	\$9.19	1
			16/3 ORANGE	6+	\$7.99	
	B	753475	50 FT. EXTENSION CORD	1-5	\$17.23	1
			16/3 ORANGE	6+	\$14.99	
	C	240705	100 FT. EXTENSION CORD	1-5	\$26.43	1
			16/3 ORANGE	6+	\$22.99	
	D	455899	4 FT. RANGE CORD - 50 AMP.	1-5	\$13.78	1
				6+	\$11.99	
	E	244087	6 FT. RANGE CORD - 50 AMP.	1-5	\$19.49	1
				6+	\$16.95	
	F	244145	6 FT. DRYER CORD - 30 AMP.	1-5	\$9.76	1
				6+	\$8.49	
	G	536920	4' DRYER CORD	1-5	\$10.49	1
			220V 4 PRONG	6+	\$9.99	
	H	08744	3' 14/3 A/C CORD EXTENSION	1-5	\$4.69	
				6+	\$4.08	
	I	08748	6' 14/3 A/C CORD EXTENSION	1-5	\$7.41	1
				6+	\$6.45	





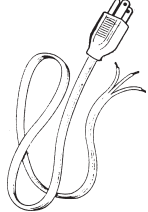
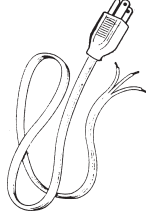
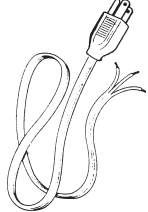

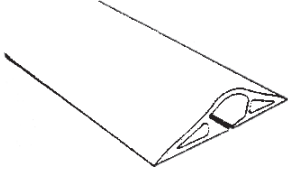
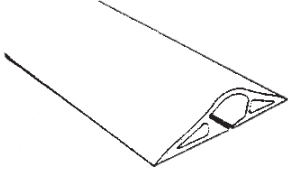

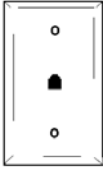

# WIRE

# ELECTRICAL

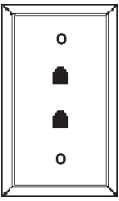

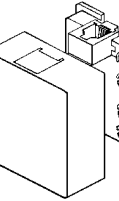

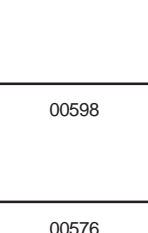
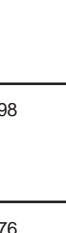
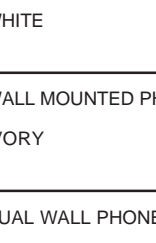
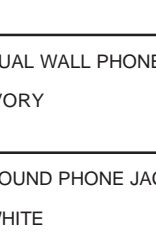



PART #	ITEM	1-5	\$	PK*	
A	513473 #14 WHITE SOLID WIRE	1-5	\$71.30	1	
	500 FT. ROLL	6+	\$62.00		
B	513465 #14 BLACK SOLID WIRE	1-5	\$71.30	1	
	500 FT. ROLL	6+	\$62.00		
C	513481 #14 RED SOLID WIRE	1-5	\$71.30	1	
	500 FT. ROLL	6+	\$62.00		
D	513507 #14 GREEN SOLID WIRE	1-5	\$71.30	1	
	500 FT. ROLL	6+	\$62.00		
E	513515 #12 BLACK SOLID WIRE	1-5	\$106.95		
	500 FT. ROLL	6+	\$93.00		
F	08576 3 FT. STRAIGHT PIGTAIL	1-5	\$3.73	1	
		6+	\$3.25		
G	08580 6 FT. STRAIGHT PIGTAIL	1-5	\$5.46	1	
		6+	\$4.75		
H	08590 8 FT. STRAIGHT PIGTAIL	1-5	\$6.03	1	
		6+	\$5.25		
I	110437 25' 14/2 ROMEX WIRE	1-5	\$17.24	1	
		6+	\$14.99		
J	110684 50' 14/2 ROMEX WIRE	1-5	\$32.49	1	
		6+	\$27.99		
K	543473 15' CORD GUARD	1-5	\$29.90	1	
	GRAY	6+	\$26.00		
L	09735 15' CORD GUARD	1-5	\$29.90	1	
	BEIGE	6+	\$26.00		
M	07158 7 1/2" 12 GA GROUND PIGTAIL	1-5	\$0.63		
		6+	\$0.55		



	PART #	ITEM			PK*
	A 87510	PHONE JACK PLATE	1-5	\$1.24	1
		WHITE	6+	\$1.08	
	B 87512	PHONE JACK PLATE	1-5	\$1.24	1
		IVORY	6+	\$1.08	
	C 00597	WALL MOUNTED PHONE JACK	1-5	\$1.66	10
		WHITE	6+	\$1.45	
	D 00598	WALL MOUNTED PHONE JACK	1-5	\$1.66	10
		IVORY	6+	\$1.45	
	E 00576	DUAL WALL PHONE JACK	1-5	\$2.58	10
		WHITE	6+	\$2.25	
	F 00599	DUAL WALL PHONE JACK	1-5	\$2.58	10
		IVORY	6+	\$2.25	
	G 793463	ROUND PHONE JACK PLATE	1-5	\$1.51	1
		WHITE	6+	\$1.32	
	H 488510	ROUND PHONE JACK PLATE	1-5	\$1.51	1
		IVORY	6+	\$1.32	
	I 803442	SQUARE PHONE JACK	1-5	\$1.25	1
		SURFACE MOUNT-WHITE	6+	\$1.09	
	J 336065	SQUARE PHONE JACK	1-5	\$1.25	1
		SURFACE MOUNT-IVORY	6+	\$1.09	

# TELEPHONE ACCESSORIES

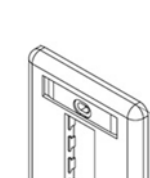
*ELECTRICAL*

PART #	ITEM	PK*			
A	3595	DECORA PHONE JACK	1-5	\$3.89	
		WHITE	6+	\$3.39	
B	22307	DECORA PHONE JACK	1-5	\$4.12	
		BLACK	6+	\$3.59	
C	40585	PHONE/VIDEO JACK	1-5	\$2.81	
		WHITE COMBO	6+	\$2.45	
D	41190	DECORA VIDEO JACK	1-5	\$4.54	
		WHITE	6+	\$3.95	
E	3346	PHONE JACK INSERT	1-5	\$5.00	
		WHITE-ORTRONICS	6+	\$4.35	
F	3347	CABLE JACK INSERT	1-5	\$3.77	
		WHITE-ORTRONICS	6+	\$3.28	
G	3348	DUMMY INSERT	1-5	\$4.92	
		WHITE-ORTRONICS	6+	\$4.28	
H	3349	3 POSITION PLATE	1-5	\$2.57	
		WHITE-ORTRONICS	6+	\$2.24	

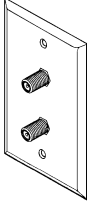
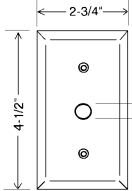

	PART #	ITEM			PK*
	A	COAX WALL PLATE	1-5	\$1.43	1
		WHITE	6+	\$1.25	
	B	COAX WALL PLATE	1-5	\$1.43	1
		IVORY	6+	\$1.25	
	C	DUAL COAX WALL PLATE	1-5	\$2.53	1
		WHITE	6+	\$2.20	
	D	DUAL COAX WALL PLATE	1-5	\$2.53	1
		IVORY	6+	\$2.20	
	E	COAX CABLE WALL PLATE	1-5	\$0.36	1
		W/ 5/8" HOLE - WHITE	6+	\$0.32	
	F	COAX CABLE WALL PLATE	1-5	\$0.36	1
		W/ 5/8" HOLE - IVORY	6+	\$0.32	



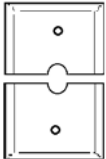
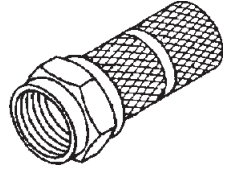
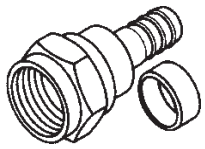
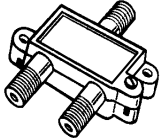
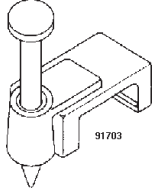

# CABLE T.V. ACCESSORIES

**ELECTRICAL**



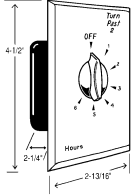

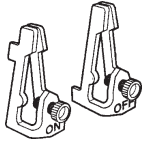
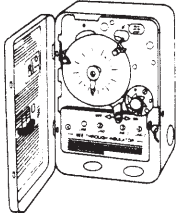
PART #	ITEM	1-5	6+	\$	PK*	
A	00596	SPLIT CABLE PLATE	1-5	\$2.24	1	
		W/ 5/8" HOLE - WHITE	6+	\$1.95		
B	00548	TWIST ON COAX CABLE	1-5	\$0.48	1	
		CONNECTOR	6+	\$0.42		
C	91743	CABLE CONNECTOR W/	1-5	\$0.42	1	
		FERRULE FOR R-6 CABLE	6+	\$0.37		
D	408740	2 WAY CABLE SPLITTER	1-5	\$2.35	1	
			6+	\$2.05		
E	91703	COAX CABLE STAPLES	1-5	\$3.73	1	
		WHITE-100 PK	6+	\$3.25		



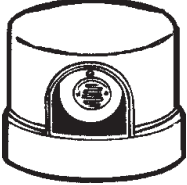

	<b>PART #</b>	<b>ITEM</b>			<b>PK*</b>
	A 76971	15 MINUTE SPRING WOUND TIMER SWITCH	1-5	\$21.21	1
			6+	\$18.45	
	B 76972	30 MINUTE SPRING WOUND TIMER SWITCH	1-5	\$22.94	1
			6+	\$19.95	
	C 76974	60 MINUTE SPRING WOUND TIMER SWITCH	1-5	\$22.94	1
			6+	\$19.95	
	D 76975	KNOB ONLY FOR SPRING WOUND TIMER	1-5	\$1.25	1
			6+	\$1.09	
	E 3252	TIME CLOCK TRIPPER PAIR	1-5	\$2.17	1
			6+	\$1.89	
	F 249169	T -101 MECHANICAL TIME SWITCH 120 VOLT/SINGLE POLE	1-5	\$57.44	1
			6+	\$49.95	
	G 76964	T-104 MECHANICAL TIME SWITCH 220 VOLT/60HZ DOUBLE POLE/SINGLE THROW	1-5	\$65.37	1
			6+	\$56.85	

# PHOTOCELLS

*ELECTRICAL*

PART #	ITEM		PK*		
A	87500	PHOTO ELECTRIC CONTROL	1-5	\$7.11	1
		IN/OUTDOOR 1200W / 120 VOLT	6+	\$6.19	
					
B	87501	PHOTO ELECTRIC CONTROL	1-5	\$10.22	1
		IN/OUTDOOR 1800W / 120 VOLT	6+	\$8.89	
					
C	00568	PHOTO ELECTRIC CONTROL	1-5	\$6.70	1
		TWISTLOCK / 1000 WATT	6+	\$5.83	
					
D	76970	PHOTOCONTROL	1-5	\$11.25	
		UP TO 1800 WATTS	6+	\$9.79	
		BUILT-IN TIMER DELAY			
					

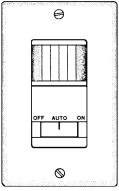
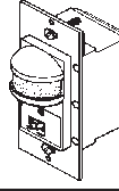
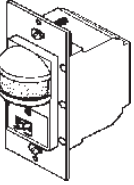





	PART #	ITEM			PK*
	A 70695	MOTIONSENSOR-WHITE	1-5	\$22.18	1
		500 WATT INCAND.	6+	\$19.29	
		400 WATT FLUOR			
	B 70697	MOTION SENSOR-IVORY	1-5	\$22.18	1
		500 WATT INCAND.	6+	\$19.29	
		400 WATT FLUOR			
	C 70691	LEVITON MOTION SENSOR	1-5	\$66.64	1
		WHITE, 500 WATT	6+	\$57.95	
	D 3410	MOTIONSENSOR-WHITE	1-5	\$40.19	
		SWITCH WITH NIGHT LIGHT	6+	\$34.95	
		600 WATT, 30 MIN. TIME DELAY			





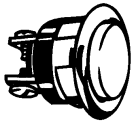
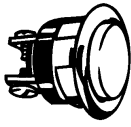

# DOORBELL PUSH BUTTONS

*ELECTRICAL*

PART #	ITEM	1-5	6+	PK*
A	88152 COLONIAL LIGHTED PUSH	1-5	\$3.89	1
	BUTTON - BLACK	6+	\$3.38	
				
B	00549 SLIMLINE LIGHTED PUSH	1-5	\$4.54	1
	BUTTON - BLACK	6+	\$3.95	
				
C	3361 NUTONE DOOR BELL PUSH	1-5	\$4.70	1
	BUTTON 2 1/2" WHITE	6+	\$4.09	
	LIGHTED			
				
D	766566 DOOR BELL PUSH BUTTON	1-5	\$1.82	1
	NON-LIGHTED, 5/8" DIA.	6+	\$1.59	
	BRASS			
				
E	529554 DOOR BELL PUSH BUTTON	1-5	\$2.99	1
	LIGHTED, 5/8" DIA.	6+	\$2.58	
	BRASS			
				
F	3359 NUTONE DOOR BELL PUSH	1-5	\$8.49	1
	BUTTON 2 1/2" BRONZE	6+	\$7.39	
	LIGHTED			
G	3360 NUTONE DOOR BELL PUSH	1-5	\$8.49	1
	BUTTON 2 1/2" SATIN NICKEL	6+	\$7.39	
	LIGHTED			
H	88151 NUTONE DOOR BELL PUSH	1-5	\$6.31	1
	BUTTON 2 1/2" BRASS	6+	\$5.49	
	NON-LIGHTED			
				
I	3396 NUTONE DOORBELL	1-5	\$8.49	
	BUTTON LIGHTED	6+	\$7.39	
	WHITE			
J	88169 NUTONE DOOR BELL PUSH	1-5	\$8.49	1
	BUTTON 2 1/2" BRASS	6+	\$7.39	
	LIGHTED			





	<b>PART #</b>	<b>ITEM</b>			<b>PK*</b>
	A 00539	DOORBELL TRANSFORMER	1-5	\$6.31	1
		16 VOLT - 10VA	6+	\$5.49	
	B 88149	BROAN DOOR BELL	1-5	\$17.19	1
		USE TRANSFORMER # 00539 WHITE	6+	\$14.95	
	C 00916	NUTONE MANUAL DOOR BELL	1-5	\$38.47	1
		WITH VIEWER - WHITE	6+	\$33.46	
	D 3546	AUTH-CHIMES MAN. DOOR BELL	1-5	\$22.98	
		WITH VIEWER-ALUMINUM	6+	\$19.99	



# DOORCHIMES

# ELECTRICAL

PART #	ITEM				PK*	
A	99856	NUTONE DOOR CHIME COVER	1-5	\$9.13	1	
		WHITE 7" X 5"	6+	\$7.94		
B	00560	NUTONE DOOR BELL COVER	1-5	\$7.47	1	
		WHITE 4" X 6 3/4"	6+	\$6.50		
C	01096	NUTONE COMPLETE DOOR BELL	1-5	\$18.46	1	
		WHITE 7" X 5"	6+	\$17.14		
D	342447	WIRELESS DOORBELL	1-5	\$20.68		
		IVORY-RC3510 DLX	6+	\$17.99		
		BATTERY OPERATED 150 FT RANGE				
		4-"C" CELL BATTERIES NOT INCLUDED				

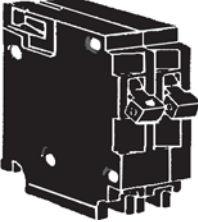

# ELECTRICAL INTERCHANGEABLE CIRCUIT BREAKERS

	PART #	ITEM		1-5	\$	PK*
	A 06488	15 AMP SINGLE POLE		1-5	\$4.88	1
		INTERCHANGEABLE		6+	\$4.25	
		MP115				
	B 06492	20 AMP SINGLE POLE		1-5	\$4.88	1
		INTERCHANGEABLE		6+	\$4.25	
		MP120				
	C 06387	15 AMP TWIN SINGLE POLE		1-5	\$12.82	1
		INTERCHANGEABLE		6+	\$11.15	
		MP1515				
	D 06389	20 AMP TWIN SINGLE POLE		1-5	\$12.82	1
		INTERCHANGEABLE		6+	\$11.15	
		MP2020				
	E 00559	30 AMP TWIN SINGLE POLE		1-5	\$28.69	1
		INTERCHANGEABLE		6+	\$24.95	
		MP3030				



# INTERCHANGEABLE CIRCUIT BREAKERS *ELECTRICAL*

PART #	ITEM	PK*
A	06512 20 AMP DOUBLE POLE INTERCHANGEABLE MP220	1-5 \$12.01 1 6+ \$10.45
B	06516 30 AMP DOUBLE POLE INTERCHANGEABLE MP230	1-5 \$12.01 1 6+ \$10.45
C	06520 40 AMP DOUBLE POLE INTERCHANGEABLE MP240	1-5 \$12.01 1 6+ \$10.45
D	06524 50 AMP DOUBLE POLE INTERCHANGEABLE MP250	1-5 \$12.01 1 6+ \$10.45
E	06522 60 AMP DOUBLE POLE INTERCHANGEABLE MP260	1-5 \$12.01 1 6+ \$10.45
F	695353 70 AMP DOUBLE POLE INTERCHANGEABLE MP270	1-5 \$28.69 1 6+ \$24.95
G	91530 90 AMP DOUBLE POLE INTERCHANGEABLE MP290	1-5 \$37.89 1 6+ \$32.95
H	06525 100 AMP DOUBLE POLE INTERCHANGEABLE MP2100	1-5 \$41.11 1 6+ \$35.75
I	91666 125 AMP DOUBLE POLE INTERCHANGEABLE MP2125	1-5 \$71.24 1 6+ \$61.95

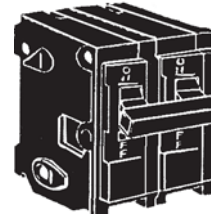

# ELECTRICAL INTERCHANGEABLE CIRCUIT BREAKERS

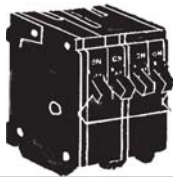
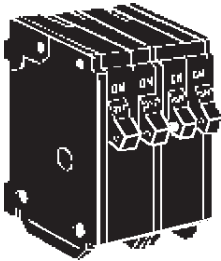
	PART #	ITEM	1-5	\$34.44	PK*
	A 06530	40 AMP TWIN DOUBLE POLE	1-5	\$34.44	1
		INTERCHANGEABLE MP24040	6+	\$29.95	
<hr/>					
	B 06398	15-20/20-15 AMP QUADPLEX	1-5	\$34.44	1
		INTERCHANGEABLE MP22015	6+	\$29.95	
<hr/>					
	C 06399	20-20/20-20 AMP QUADPLEX	1-5	\$34.44	1
		INTERCHANGEABLE MP22020	6+	\$29.95	
<hr/>					
	D 06994	15-30/30-15 QUADPLEX	1-5	\$34.44	1
		INTERCHANGEABLE MP23015	6+	\$29.95	
<hr/>					
	E 06401	20-30/30-20 AMP QUADPLEX	1-5	\$34.44	1
		INTERCHANGEABLE MP23020	6+	\$29.95	
<hr/>					
	F 06402	20-40/40-20 AMP QUADPLEX	1-5	\$34.44	1
		INTERCHANGEABLE MP24020	6+	\$29.95	
<hr/>					
	G 06403	20-50/50-20 AMP QUADPLEX	1-5	\$34.44	1
		INTERCHANGEABLE MP25020	6+	\$29.95	







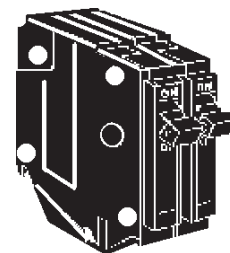
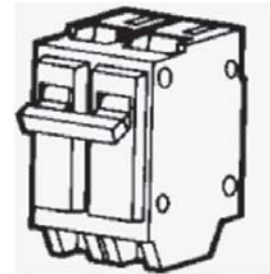
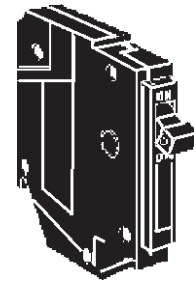

# G.E. CIRCUIT BREAKERS

*ELECTRICAL*

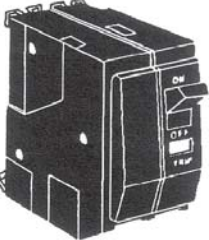
PART #	ITEM	PK*
A	06560 15 AMP SINGLE POLE G.E. CIRCUIT BREAKER THQP115	1-5 \$7.34 6+ \$6.39
B	06564 20 AMP SINGLE POLE G.E. CIRCUIT BREAKER THQP1120	1-5 \$7.34 6+ \$6.39
C	06568 30 AMP SINGLE POLE G.E. CIRCUIT BREAKER THQP1130	1-5 \$7.07 6+ \$6.15
D	704171 15 AMP DOUBLE POLE 2" THICK G.E. CIRCUIT BREAKER THQL2115	1-5 \$20.64 6+ \$17.95
E	06544 20 AMP TQL DOUBLE POLE G.E. CIRCUIT BREAKER THQL2120	1-5 \$20.64 6+ \$17.95
F	06548 30 AMP TQL DOUBLE POLE G.E. CIRCUIT BREAKER THQL2130	1-5 \$20.64 6+ \$17.95
G	06552 40 AMP TQL DOUBLE POLE G.E. CIRCUIT BREAKER THQL2140	1-5 \$20.64 6+ \$17.95
H	06556 50 AMP TQL DOUBLE POLE G.E. CIRCUIT BREAKER THQL2150	1-5 \$20.64 6+ \$17.95
I	06572 15 AMP TQP DOUBLE POLE G.E. CIRCUIT BREAKER THQP215	1-5 \$15.23 6+ \$13.25
J	06576 20 AMP TQP DOUBLE POLE G.E. CIRCUIT BREAKER THQP220	1-5 \$15.23 6+ \$13.25
K	06580 30 AMP TQP DOUBLE POLE G.E. CIRCUIT BREAKER THQP230	1-5 \$15.23 6+ \$13.25
L	06584 40 AMP TQP DOUBLE POLE THICK G.E. CIRCUIT BREAKER THQP240	1-5 \$15.23 6+ \$13.25
M	06588 50 AMP TQP DOUBLE POLE G.E. CIRCUIT BREAKER THQP250	1-5 \$15.23 6+ \$13.25

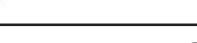

	PART #	ITEM			PK*
	A 3351	15/15	1-5	\$20.70	1
		SQUARE D BREAKER	6+	\$18.00	
		HOMT1515			
	B 3343	15/20	1-5	\$20.70	1
		SQUARE D BREAKER	6+	\$18.00	
		HOMT1520			
	C 3344	20/20	1-5	\$20.70	1
		SQUARE D BREAKER	6+	\$18.00	
		HOMT2020			
	D 3345	20/30/30/20	1-5	\$37.95	1
		SQUARE D BREAKER	6+	\$33.00	
		HOMT2020230			
	E 06592	15 AMP SINGLE POLE	1-5	\$9.37	1
		SQUARE D BREAKER	6+	\$8.15	
		Q0115			
	F 06596	20 AMP SINGLE POLE	1-5	\$9.37	1
		SQUARE D BREAKER	6+	\$8.15	
		Q0120			
	G 06600	30 AMP SINGLE POLE	1-5	\$9.37	1
		SQUARE D BREAKER	6+	\$8.15	
		Q0130			
	H 06616	20 AMP DOUBLE POLE	1-5	\$29.84	1
		SQUARE D BREAKER	6+	\$25.95	
		Q0220			
	I 06620	30 AMP DOUBLE POLE	1-5	\$29.84	1
		SQUARE D BREAKER	6+	\$25.95	
		Q0230			
	J 06624	40 AMP DOUBLE POLE	1-5	\$29.84	1
		SQUARE D BREAKER	6+	\$25.95	
		Q0240			
	K 241711	60 AMP DOUBLE POLE	1-5	\$29.84	1
		SQUARE D BREAKER	6+	\$25.95	
		Q0260			





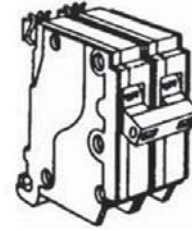

# CUTLER HAMMER CIRCUIT BREAKERS

*ELECTRICAL*

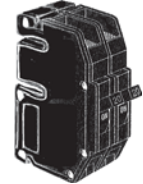

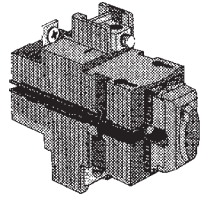



PART #	ITEM				PK*
A	06685	20 AMP DOUBLE POLE	1-5	\$21.27	1
		CUTLER HAMMER	6+	\$18.50	
		CH220			
B	06686	30 AMP DOUBLE POLE	1-5	\$21.27	1
		CUTLER HAMMER	6+	\$18.50	
		CH230			
C	06687	50 AMP DOUBLE POLE	1-5	\$21.27	1
		CUTLER HAMMER	6+	\$18.50	
		CH250			



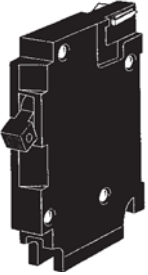
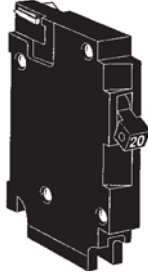



	PART #	ITEM			PK*
	A 728813	15 AMP TWIN SINGLE POLE	1-5	\$45.99	1
		ZINSCO	6+	\$39.99	
		UBIZ1515			
	B 91590	15/20 AMP TWIN SINGLE POLE	1-5	\$45.98	1
		ZINSCO	6+	\$39.99	
		UBIZ1520			
	C 728876	20 AMP TWIN SINGLE POLE	1-5	\$57.44	1
		ZINSCO	6+	\$49.95	
		UBIZ2020			
	D 06469	30 AMP TWIN SINGLE POLE	1-5	\$57.44	1
		ZINSCO	6+	\$49.95	
		UBIZ3030			
	E 06446	40 AMP DBL POLE	1-5	\$57.44	1
		ZINSCO	6+	\$49.95	
		UBIZ240			
	F 06636	20 AMP SINGLE POLE	1-5	\$25.81	1
		ZINSCO	6+	\$22.45	
		UBIZ20			
	G 06467	30 AMP SINGLE POLE	1-5	\$36.16	1
		ZINSCO	6+	\$31.45	
		UBIZ30			
	H 3008	BUSS BAR SET	1-5	\$132.25	1
		ZINSCO	6+	\$115.00	
	I 744888	50 AMP DOUBLE POLE	1-5	\$52.84	1
		PUSHMATIC	6+	\$45.95	
		UBIP250			

# CIRCUIT BREAKERS

**ELECTRICAL**



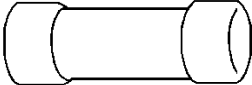





PART #	ITEM	1-5	6+	\$	PK*	
A	3012	15 AMP SINGLE POLE PLUG IN	1-5	\$17.76	1	
		RIGHT HAND	6+	\$15.45		
		A115R				
B	3013	20 AMP SINGLE POLE PLUG IN	1-5	\$17.76	1	
		RIGHT HAND	6+	\$15.45		
		A120R				
C	3022	15 AMP SINGLE POLE PLUG IN	1-5	\$17.76	1	
		LEFT HAND	6+	\$15.45		
		A115L				
D	3023	20 AMP SINGLE POLE PLUG IN	1-5	\$17.76	1	
		LEFT HAND	6+	\$15.45		
		A120L				
E	3010	15 AMP DOUBLE POLE PLUG IN	1-5	\$45.94	1	
		A215	6+	\$39.95		
F	3024	20 AMP DOUBLE POLE PLUG IN	1-5	\$45.94	1	
		A220	6+	\$39.95		
G	3025	30 AMP DOUBLE POLE PLUG IN	1-5	\$45.94	1	
		A230	6+	\$39.95		
H	3026	40 AMP DOUBLE POLE PLUG IN	1-5	\$45.94	1	
		A240	6+	\$39.95		
I	06384	15 AMP SINGLE POLE	1-5	\$24.43	1	
		FEDERAL	6+	\$21.25		
		UBIF-15N				
J	06388	20 AMP SINGLE POLE	1-5	\$24.43	1	
		FEDERAL	6+	\$21.25		
		UBIF-20N				
K	06408	15 AMP DOUBLE POLE FEDERAL	1-5	\$53.53	1	
		FEDERAL	6+	\$46.55		
		UBIF-021N				
L	06407	20 AMP DOUBLE POLE FEDERAL	1-5	\$53.53	1	
		FEDERAL	6+	\$46.55		
		UBIF-0220N				
M	06409	30 AMP DOUBLE POLE FEDERAL	1-5	\$53.53	1	
		FEDERAL	6+	\$46.55		
		UBIF-0230N				
N	06413	50 AMP DOUBLE POLE FEDERAL	1-5	\$53.53	1	
		FEDERAL	6+	\$46.55		
		UBIF-0250N				

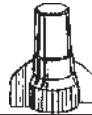

	PART #	ITEM			PK*
	A 07768	15 AMP FRN FUSTRON	1-5	\$3.04	
			6+	\$2.65	
	B 07772	20 AMP FRN FUSTRON	1-5	\$3.04	
			6+	\$2.65	
	C 07776	25 AMP FRN FUSTRON	1-5	\$3.27	
			6+	\$2.85	
	D 411025	30 AMP TIME DELAY FUSE	1-5	\$3.04	10
		2" LONG, FRN-R-30	6+	\$2.65	
	E 07740	35 AMP FUSE	1-5	\$5.00	10
		3" LONG FRN-R-35	6+	\$4.35	
	F 411421	40 AMP TIME DELAY FUSE	1-5	\$5.85	10
		3" LONG, FRN-R-40	6+	\$5.09	
	G 411934	50 AMP TIME DELAY FUSE	1-5	\$5.00	10
		3" LONG, FRN-R-50	6+	\$4.35	
	H 411991	60 AMP TIME DELAY FUSE	1-5	\$5.00	10
		3" LONG, FRN-R-60	6+	\$4.35	
	I 10486	20 AMP APPLIANCE FUSE	1-5	\$7.99	10
		ABC 20, 250 VOLT 5 PK.	6+	\$6.95	
	J 3292	5 AMP GLASS FUSE FOR ALARM	1-5	\$1.73	5
			6+	\$1.50	
	K 739060	3/4" X 60' ELECTRICAL TAPE	1-5	\$0.55	1
			6+	\$0.48	
	L 164726	3/4" X 66' ALL WEATHER	1-5	\$3.44	1
		ELECTRICAL TAPE	6+	\$2.99	

# WIRE CONNECTORS

**ELECTRICAL**

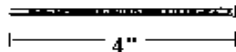
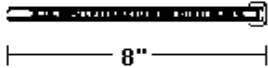
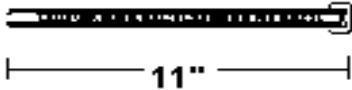
PART #	ITEM	PK*				
A	317230 BLUE WIRE NUT, 100 PK.	1-5	\$5.57	1		
		6+	\$4.85			
B	240390 ORANGE WIRE NUT, 100 PK.	1-5	\$6.26	1		
		6+	\$5.45			
C	240408 YELLOW WIRE NUT, 100 PK.	1-5	\$7.76	1		
		6+	\$6.75			
D	240416 RED WIRE NUT, 100 PK.	1-5	\$9.71	1		
		6+	\$8.45			
E	474262 YELLOW WINGED WIRE NUT 100 PK.	1-5	\$9.14	1		
		6+	\$7.95			
F	760134 YELLOW WIRE CONNECTOR 200PK	1-5	\$15.51			
		6+	\$13.49			
G	474270 RED WINGED WIRE NUT 100 PK	1-5	\$9.20	1		
		6+	\$8.00			
H	760142 RED WIRE CONNECTOR 125PK	1-5	\$11.50			
		6+	\$10.00			
I	07182 SMALL PORCELAIN WIRE CONNECTOR	1-5	\$0.28	100		
		6+	\$0.25			
J	3287 4" WHITE NYLON TIE 100 PACK	1-5	\$3.73	1		
		6+	\$3.25			
K	670901 8" WHITE NYLON TIE 100 PACK	1-5	\$5.46	1		
		6+	\$4.75			
L	670919 11" WHITE NYLON TIE 100 PACK	1-5	\$7.81	1		
		6+	\$6.79			









	PART #	ITEM			PK*
	A 91724	4 PK. AAA PROCELL ALKALINE	1-5	\$2.28	6
		BATTERY BY DURACELL	6+	\$1.99	
	B 91723	4 PK. AA PROCELL ALKALINE	1-5	\$1.94	6
		BATTERY BY DURACELL	6+	\$1.69	
	C 91726	1 PK. C PROCELL ALKALINE	1-5	\$1.26	12
		BATTERY BY DURACELL (12 PER CASE)	6+	\$1.10	
	D 91725	1 PK. D PROCELL ALKALINE	1-5	\$1.26	12
		BATTERY BY DURACELL (12 PER CASE)	6+	\$1.10	
	E 91727	1 PK. 9 VOLT PROCELL ALKALINE	1-5	\$1.66	12
		BATTERY BY DURACELL (12 PER CASE)	6+	\$1.45	
	F 109184	2 PK. A-23 ENERGIZER	1-5	\$3.54	6
		BATTERY/GARAGE OPENER 12VOLT	6+	\$3.08	

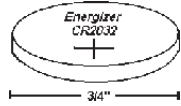
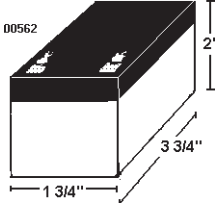

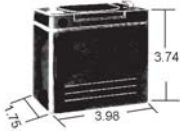

# BATTERIES

# ELECTRICAL

PART #	ITEM	PK*
A	352333 ENERGIZER 3 VOLT LITHIUM BATTERY ECR2032	1-5 \$2.04 6 LLL 6+ \$1.77
		
B	00562 12 VOLT EMERGENCY DOOR BATTERY, 1.2 AMP HOUR	1-5 \$19.32 1 6+ \$16.80
		
C	3288 12 VOLT BATTERY 7.2 AMP HOUR	1-5 \$25.30 1 6+ \$22.00
		
D	3290 4 VOLT BATTERY 9.0 AMP HOUR	1-5 \$25.30 1 6+ \$22.00
		
E	3002 12 VOLT 4 AMP HOUR BATTERY	1-5 \$25.30 1 6+ \$22.00
		
F	334276 3 VOLT LITH BATTERY	1-5 \$2.03 6+ \$1.77
		
G	257303 6 VOLT HD SPRING BATTERY	1-5 \$6.88 6+ \$5.99
		

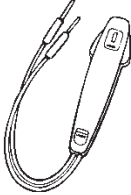
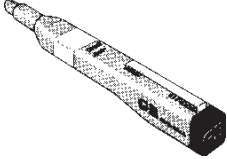
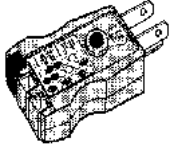
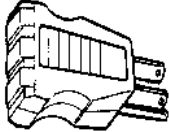
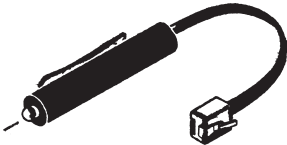
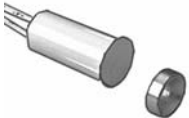



	PART #	ITEM			PK*
	A 91451	ALARM TRANSFORMER	1-5	\$9.14	1
		16.5 VOLT	6+	\$7.95	
	B 248252	CIRCUIT TESTER TWIN PROBE	1-5	\$2.63	1
		CHECKS 90-500 VOLTS	6+	\$2.29	
	C 473614	CIRCUIT ALERT TESTER	1-5	\$12.59	1
		CHECKS 50-600 VOLTS	6+	\$10.95	
	D 711765	GFCI CIRCUIT ANALYZER FOR	1-5	\$10.56	1
		110 VOLT AND STANDARD CIRCUITS	6+	\$9.19	
	E 11861	RECEPTACLE CIRCUIT	1-5	\$7.47	1
		ANALYZER 3 WIRE	6+	\$6.50	
	F 00532	TELEPHONE LINE TESTER	1-5	\$12.59	1
			6+	\$10.95	
	G 3303	STUBBY AFOR ALARM	1-5	\$2.24	
		12 VOLT	6+	\$1.95	
	H 3310	ALARM MAGNET 2 PART	1-5	\$3.56	
		12 VOLT WITH SCREWS	6+	\$3.10	

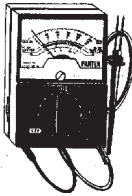
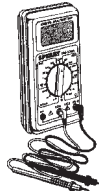

# TESTERS, BULB CHANGERS

**ELECTRICAL**

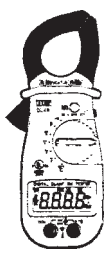
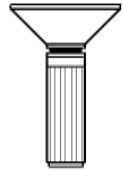
PART #	ITEM	PK*	
A 3273	MULTIMETER 5 FUNCTION 0-250VAC	1-5 \$21.26 6+ \$18.49	1
			
B 3247	3-1/2" DIGITAL MULTIMETER 5 FUNCTION 0.5A, 250V	1-5 \$25.29 6+ \$21.99	1
			
C 3271	DIGITAL MULTIMETER AC & DC VOLTAGE-750 VOLTS	1-5 \$64.94 6+ \$41.95	1
			
D 3272	DIGITAL CLAMP-ON TESTER 40-400 AMPS, AC 600, DC 4	1-5 \$171.35 6+ \$149.00	1
			
E 869594	BULB CHANGER FITS "PAR" BULBS	1-5 \$11.49 6+ \$9.99	1
			
F 869602	BULB CHANGER FITS "R" BULBS	1-5 \$11.99 6+ \$9.99	1



